

# KODIAK



Cleaning Equipment

WALK-BEHIND SCRUBBERS RANGE

K12 | K16 | K19 | K25



**FAIRCHILD**  
EQUIPMENT

**Unleash Your Full Cleaning Potential**

Toll Free: 844-432-4724 [www.fairchildequipment.com](http://www.fairchildequipment.com)

Handmade In & Imported From Wisconsin, USA

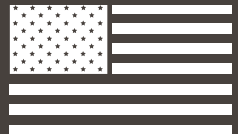



## Small K12

Clean in hard to reach areas with this small-footprint walk behind floor scrubber. Especially agile and quiet for congested areas.

- Up to 40,000 sqft Per Charge
- 12 / 15 Gallons
- 17 - 20 inch decks

### Applications

- Fabrication Shops
- Auto-Truck Dealers
- Machine Shops



## Medium K16

Additional productivity and capacity on a mid-sized walk behind scrubber. Pass easily through small doorways or elevators, with this versatile and durable platform.

- Up to 70,000 sqft Per Charge
- 16 / 16 Gallons
- 20 - 28 inch decks

### Applications

- Warehouses
- Plastic Molding
- Food Processing & Packaging



## Large K19

Reduce your time and labor cost to clean with this larger walk behind scrubber. Clean large areas simply and with predictable results while retaining medium sized footprint.

- Up to 110,000 sqft Per Charge
- 19 / 19 Gallons
- 24 - 28 inch decks

### Applications

- Aviation
- Food Processing & Packaging
- Warehouses



## Extra Large K25

Our maximum capacity and run time built with tough daily use and productivity in mind. Retains manageable footprint with excellent lines of sight for all operators.

- Up to 128,000 sqft Per Charge
- 25 / 26 Gallons
- 24 - 32 inch decks

### Applications

- Beverage Distribution
- Powder & Bulk
- Aviation

### Size Comparison Chart



= K12



= K19



= K25

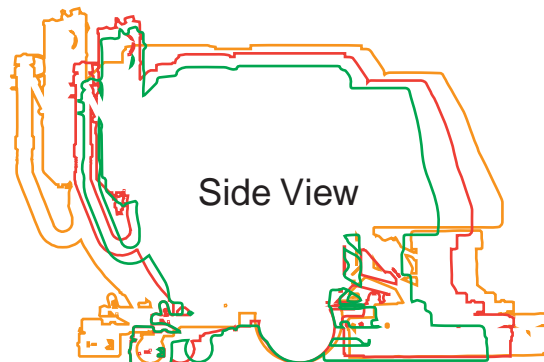

Side View

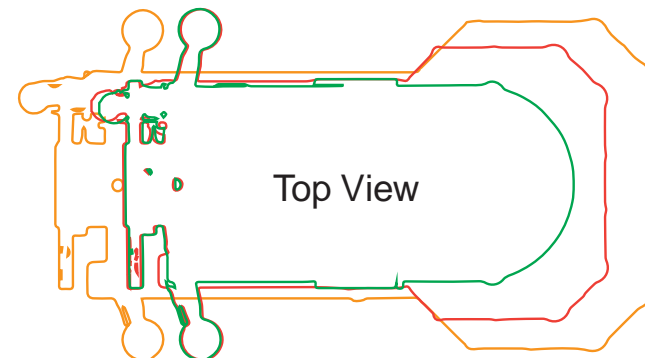

Top View

Specifications and features subject to change without notice.

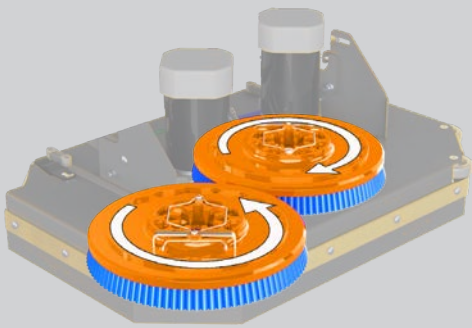

## Disk

### Benefits

- Brush / Pad Selection
- Lowest Maintenance Cost
- Improved Cleaning on Irregular Floors
- Brushes Individually Driven for Unmatched Performance

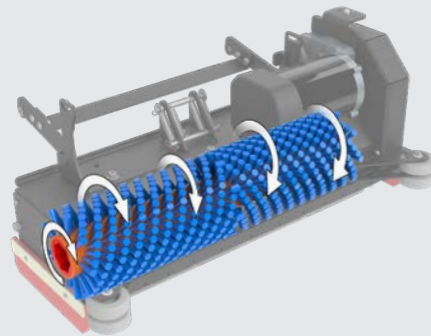

## Grout

### Benefits

- Ideal for Grouted Tile Floors
- Compact for Maneuverability
- Single Brush Simplicity
- Suitable for Rubber Athletic Floors

\*Only available on K12, no Debris Hopper.

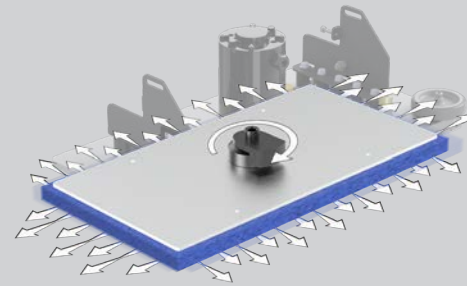

## Orbital

### Benefits

- Restore Dull Epoxy
- Reduce Slip & Fall Potential
- 70% Reduction in Water Usage
- Consistent Results - No Swirl Marks
- VCT Prep & Recoat

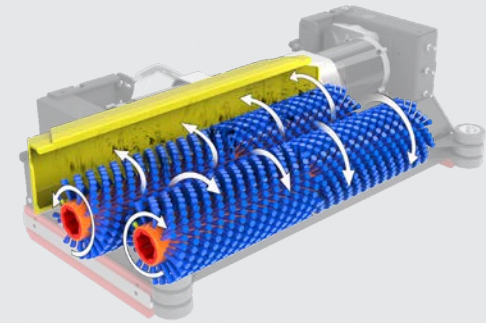

## Cylindrical

### Benefits

- Eliminates Dust Mopping
- Scrub & Sweep Simultaneously
- Superior Tile & Grout Cleaning
- Excellent on Rubber Surfaces
- Great for Warehouse Debris

\*Only available on K16, K19, & K25



26" Disk Deck on K16 Chassis Shown



24" Grout Deck on K12 Chassis Shown



24" Orbital Deck on K16 Chassis Shown



26" Cylindrical Deck on K16 Chassis Shown

## PICK THE OPTIONS



### Drain Savers & Deluxe Fill Options

Conveniently fill the floor scrubber fresh water tank from any standard faucet with the 60 inch retractable hose.



### Onboard Charger

Charge anywhere in the facility with a plug and forget charger. LED Indicator lights shows state of charge and historic charge cycle data can be downloaded for review.



### WET / AGM Battery Options

Choose between a variety of battery options for optimal run and charge times based on the application and needs.

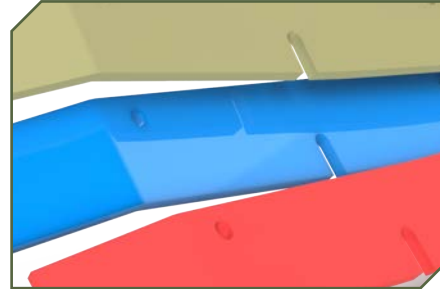

### Squeegee Blade Variations

Different applications require different squeegee material to get the job done.

- Gum Rubber
- Urethane
- Linatex®

## PICK THE BRUSH

- ① Nylon: White / Light - Soft
- ②\* Polypropylene: Black / Medium - Light
- ③ Light Grit: Grey / Medium
- ④ Midi Grit: Blue / Rough
- ⑤\* Tough Grit: Black / Very Rough
- ⑥\* Tufted Pad Driver: Red / Variety Pads

\*Not offered on Cylindrical Brushes



**Automotive**



Car dealerships often need to clean delicate showrooms as well as high traffic service areas. Our cleaning equipment has excellent visibility for the operator, rubber bumpers and a heavy duty build to operate around car lifts. Our simple controls and off the shelf marine duty switches allow for multiple operators and simple repairs.

**Warehouse**



Our cylindrical scrubbers are popular with warehouse, logistics and distribution centers due to their ability to wet sweep up small items as they scrub the dusty floors. A single machine making a single pass is convenient and easy to operate over small wood pallet chips, nails, dirt and other common debris.

**Food & Beverage**



Companies that produce, package or distribute food and beverage products have a high standard for cleanliness. Our designs are ideal for daily use and have many hand tools available for off aisle cleaning. The recovery tanks have clean-out ports for easy disposal and cleanup of the dirty water.

**Manufacturing**



As a manufacturer ourselves, our company has a good understanding of the unique needs from companies that produce products. Cutting, bending, welding, grinding, and painting metals can generate a regular need to clean. Our equipment quickly cleans up the aftermath of processing a variety of materials like steel, plastics, wood and more.



## Small K12



## Medium K16



## Large K19



## Extra Large K25

<b>Disk Scrub Path:</b>	17 & 20 in 43 & 51 cm	<b>Disk Scrub Path:</b>	20, 26 & 28 in 51, 66 & 71 cm	<b>Disk Scrub Path:</b>	26 & 28 in 66 & 71 cm	<b>Disk Scrub Path:</b>	28 & 32 in 71 & 81 cm
<b>Grout Path:</b>	24 in 61 cm	<b>Cylindrical Path:</b>	26 in 66 cm	<b>Cylindrical Path:</b>	26 in 66 cm	<b>Cylindrical Path:</b>	26 & 30 in 66 & 76 cm
<b>Orbital Path:</b>	20 & 24 in 51 & 61 cm	<b>Orbital Path:</b>	24 & 28 in 61 & 71 cm	<b>Orbital Path:</b>	24 & 28 in 61 & 71 cm	<b>Orbital Path:</b>	24 & 28 in 61 & 71 cm
<b>Dimensions (LxWxH):</b> <small>*Dimensions listed are for the largest width deck configuration and squeegees removed from the machine.</small>	49.5 x 22.5 x 38 in* 125 x 64 x 96 cm*	<b>Dimensions (LxWxH):</b> <small>*Dimensions listed are for the largest width deck configuration and squeegees removed from the machine.</small>	53 x 29 x 38.5 in* 135 x 74 x 98 cm*	<b>Dimensions (LxWxH):</b> <small>*Dimensions listed are for the largest width deck configuration and squeegees removed from the machine.</small>	53 x 29 x 38.5 in* 135 x 74 x 98 cm*	<b>Dimensions (LxWxH):</b> <small>*Dimensions listed are for the largest width deck configuration and squeegees removed from the machine.</small>	62 x 33 x 39.5 in* 157 x 84 x 100 cm*
<b>Solution Tank:</b>	12 Gal 45 L	<b>Solution Tank:</b>	16 Gal 60 L	<b>Solution Tank:</b>	19 Gal 72 L	<b>Solution Tank:</b>	25 Gal 95 L
<b>Recovery Tank:</b>	15 Gal 57 L	<b>Recovery Tank:</b>	16 Gal 60 L	<b>Recovery Tank:</b>	19 Gal 72 L	<b>Recovery Tank:</b>	26 Gal 98 L
<b>Demisting Chamber:</b>	1 Gal 4 L	<b>Demisting Chamber:</b>	1 Gal 4 L	<b>Demisting Chamber:</b>	1 Gal 4 L	<b>Demisting Chamber:</b>	2 Gal 9 L
<b>Run Time:</b> <small>*Based on continuous scrubbing run times, standard batteries, low down pressure and all options off.</small>	Up to 2 Hours*	<b>Run Time:</b> <small>*Based on continuous scrubbing run times, standard batteries, low down pressure and all options off.</small>	Up to 2.5 Hours*	<b>Run Time:</b> <small>*Based on continuous scrubbing run times, standard batteries, low down pressure and all options off.</small>	Up to 3.5 Hours*	<b>Run Time:</b> <small>*Based on continuous scrubbing run times, standard batteries, low down pressure and all options off.</small>	Up to 4 Hours*
<b>Theoretical Coverage:</b> <small>*Coverage is based off of ISSA 2010 Cleaning Times</small>	20,000 sqft/hr* 1,858 sqm/hr*	<b>Theoretical Coverage:</b> <small>*Coverage is based off of ISSA 2010 Cleaning Times</small>	28,000 sqft/hr* 2,601 sqm/hr*	<b>Theoretical Coverage:</b> <small>*Coverage is based off of ISSA 2010 Cleaning Times</small>	31,428 sqft/hr* 2,919 sqm/hr*	<b>Theoretical Coverage:</b> <small>*Coverage is based off of ISSA 2010 Cleaning Times</small>	32,000 sqft/hr* 2,973 sqm/hr*
<b>Practical Coverage:</b> <small>*Coverage is based off of ISSA 2010 Cleaning Times</small>	9,500 sqft/hr* 882 sqm/hr*	<b>Practical Coverage:</b> <small>*Coverage is based off of ISSA 2010 Cleaning Times</small>	12,800 sqft/hr* 1,189 sqm/hr*	<b>Practical Coverage:</b> <small>*Coverage is based off of ISSA 2010 Cleaning Times</small>	14,857 sqft/hr* 1,380 sqm/hr*	<b>Practical Coverage:</b> <small>*Coverage is based off of ISSA 2010 Cleaning Times</small>	15,000 sqft/hr* 1,393 sqm/charge*



Specifications and features subject to change without notice.

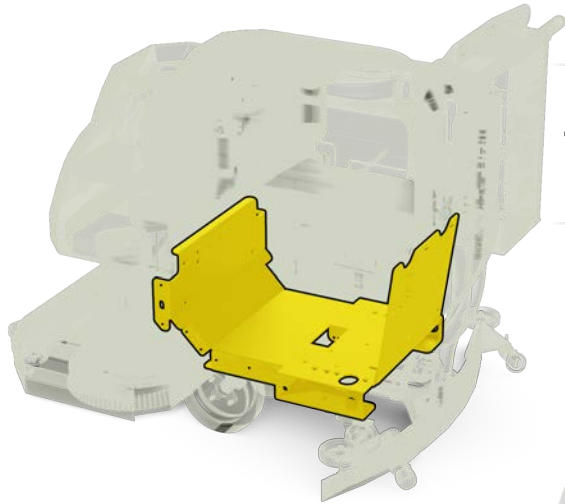

Like a heavy duty truck, the strong steel frame supports all of the systems and weight. The 4-point stance offers greater stability on irregular floors and those contact points bolt directly to the steel frame.

200 lb Capacity Sealed Actuator



### Steel Frame Attachments

- ① Scrub Deck
- ② Battery Support
- ③ Wheels/Transaxle
- ④ Squeegee Linkage
- ⑤ Tanks

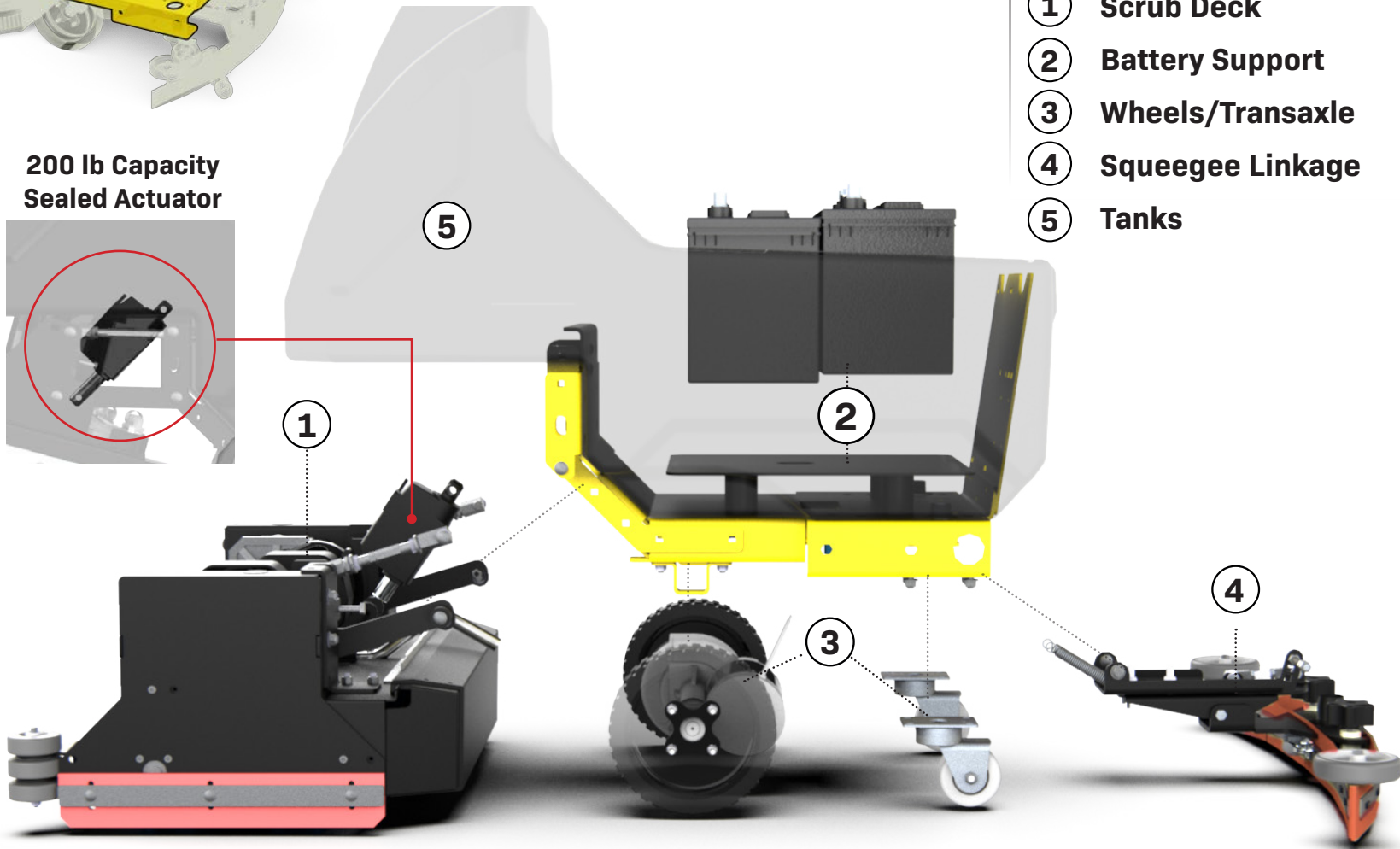

RPS “through bolts” these assemblies to the steel frame, not the tanks. No tapped steel that could rust in time.



To protect the vacuum motor from intaking moisture, our equipment has five (5) individual protective barriers

- ① Intake Curtain
- ② Shield
- ③ Stainless Vac Screen-Ball Float
- ④ White Mesh Filter
- ⑤ Stainless Screen

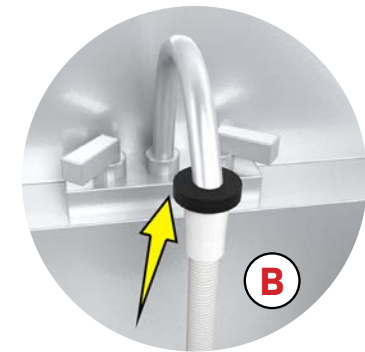

Operators can pour water into the large stainless screen through the large front funnel (A), or use the remote solution fill hose that attaches to most faucets (B).





Our central command components are simply designed making service easier than ever. We build our boxes out of steel, maintaining the integrity of the components and the machine.

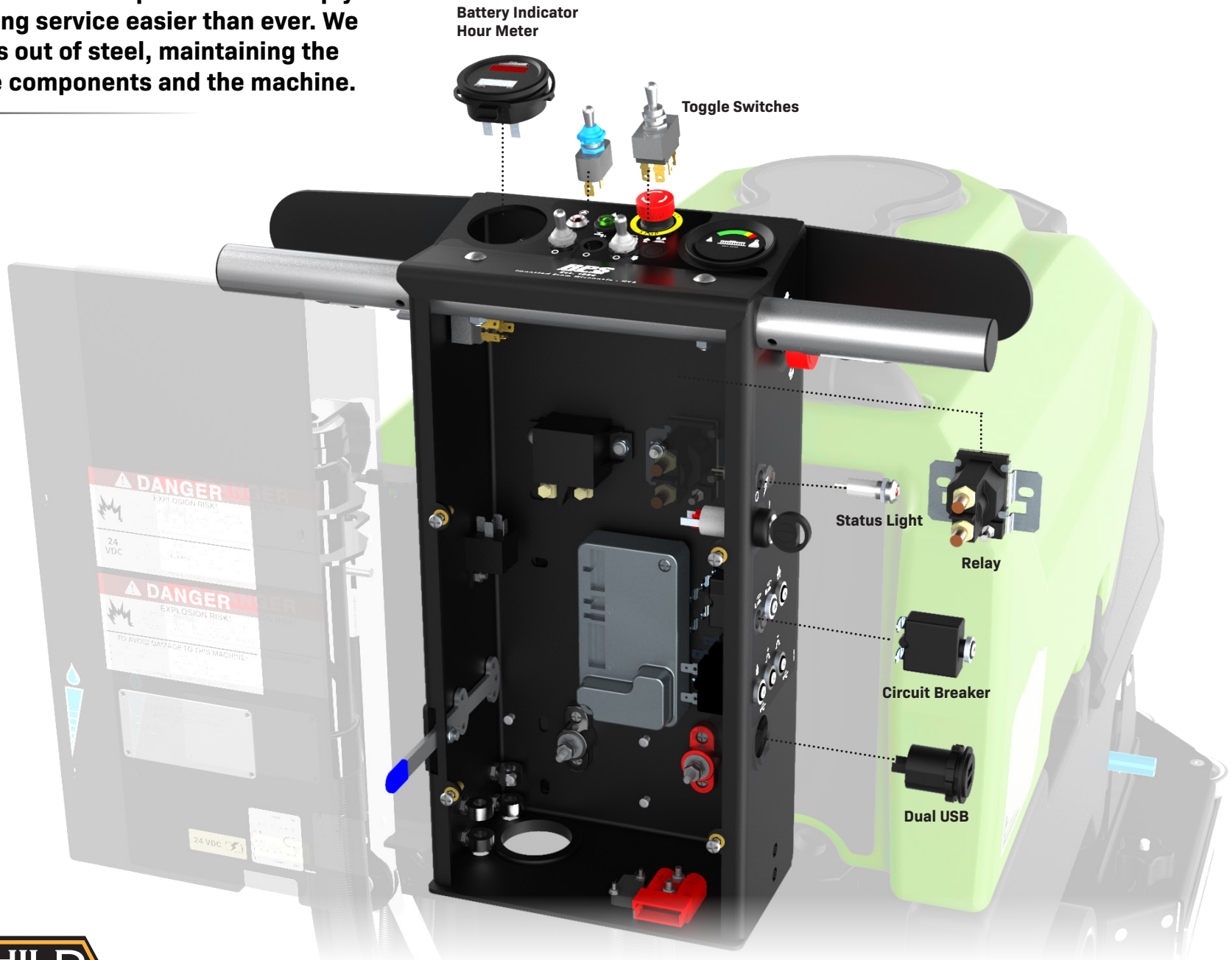

Patent pending design. If water or foam manages to get past the five protective barriers, our equipment directs the discharge out a hose to alert the operator and further guard the machine from damage.

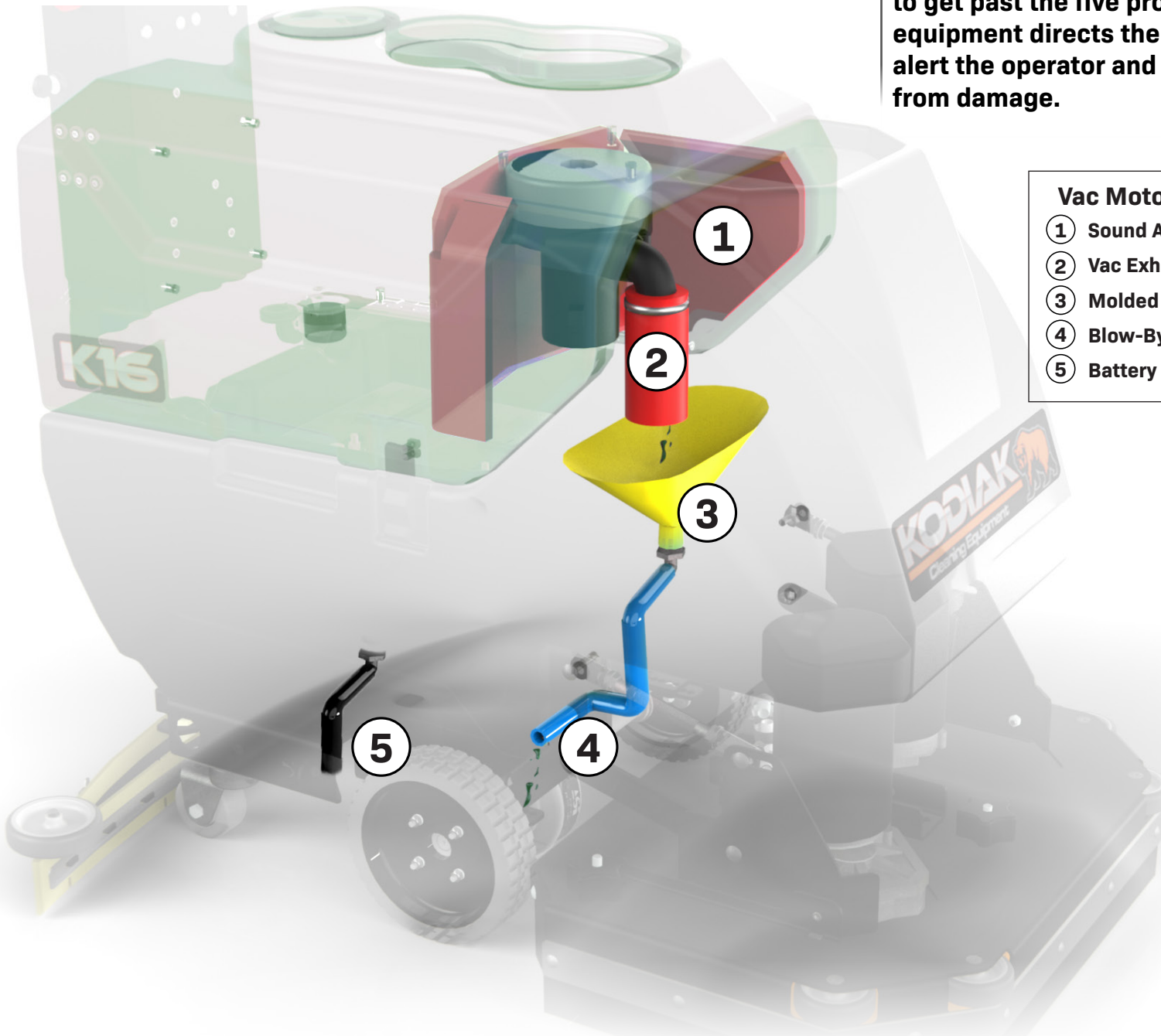

**Vac Motor Blow-By**

- ① Sound Absorbing Foam
- ② Vac Exhaust Muffler
- ③ Molded In-Tank Funnel
- ④ Blow-By Discharge Hose
- ⑤ Battery Box Drain Hose with valve



No loose fasteners

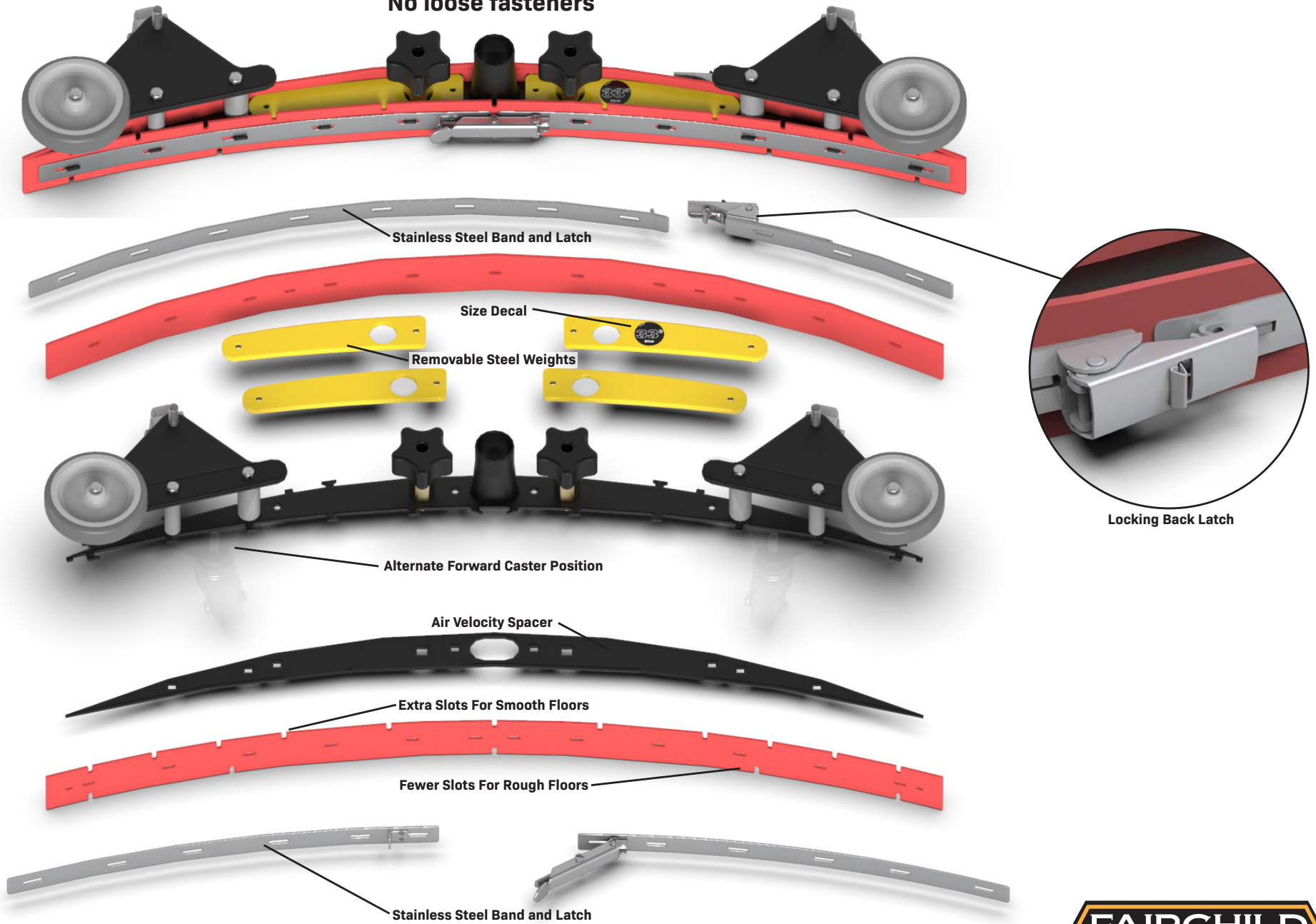

# Our Family's American Dream

RPS has been family owned from its inception in 1986, and proudly builds in Wisconsin (USA). The company has grown over the last 35-years with a strong group of executives including the 2nd generation of family owners who started in the shop as youngsters.



## Assembled By Hand

Our American workforce hand-builds each machine with components sourced over 95% from American suppliers. We routinely pay more for these domestically supplied components required to build a superior product. All design, prototyping, production and testing is done in-house where we can best control quality.

Authorized Distributor



(844) 432-4724

[fairchildequipment.com](http://fairchildequipment.com)



## Steel Fabrication

We produce heavy duty equipment and require a good amount of thick steel in the construction. We use a combination of Stainless 304 (Austenitic 18/8) and mild steel with e-coating + powder paint for corrosion resistance. Steel fabrication is done in-house or from local suppliers with specialty equipment.



## Rotational Molding

Complex shapes that allow for our tank designs are best achieved with in-house equipment. We own multiple dual station rotational molding machines that allow us to produce finished parts from raw plastic. Producing consistently higher quality parts, and respond quickly to sales spikes.

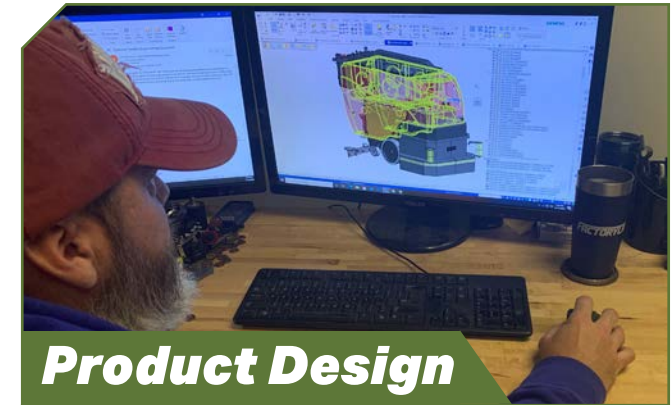

## Product Design

Our team has designed and engineered over 100 unique machines. Each new generation of machines evolve from prior designs to retain the strengths and correct any weakness. From the first pencil sketch we focus on durability, serviceability, performance, productivity, specifications, and value.