

MP 240

MODELS
24V | 36V



A VERSATILE PERSONNEL CARRIER WITH UNLIMITED CONFIGURATIONS.

The MP-240 is an economic and cost-effective vehicle that can adapt to any industry. It's narrow and maneuverable enough to fit through door openings, but tough enough to withstand years of abuse. It'll move you and your stock three times faster than on foot, quickly boosting operational productivity. Features include under-seat battery compartment, low-step entry, and front and lateral protection bars. Optional lift-out battery box and fold-down back seat. A multi-purpose vehicle offering great value and day-to-day reliability.

MODELS	LOAD CAPACITY (LBS.)	TOWING CAPACITY (LBS.)	PASSENGERS	SPEED (mph)	TURNING RADIUS (in)
24V	500	2,000	1	7	71
36V	500	6,000	1	9	71

FEATURES

- 1 Reinforced bolt-on bumper and rear wheel guards
- 2 Easy maintenance
- 3 Fatigue- and accident-saving ergonomic suspension
- 4 All-steel monocoque construction designed to last.
- 5 Powder coating and protection, very resistant



CONTACT-US







1 866 846-3558



MOTREC.COM

SPECIFICATIONS

MP 240

PERFORMANCE		24V	36V
 LOAD CAPACITY		500 lbs - 227 kg	500 lbs - 227 kg
 TOWING CAPACITY		2000 lbs - 907 kg	6000 lbs - 2722 kg
 SPEED		7 mph - 11 km/h	9 mph - 14 km/h
 TURNING RADIUS		71 in - 1803 mm	71 in - 1803 mm
 PASSENGERS		1	1
POWERTRAIN			
MOTOR	Shunt motors	6 HP	10 HP
CONTROLLER	SEPEX Electronic speed controller	✓	✓
DRIVE AXLE	Helical gear differential	✓	✓
BRAKES	Dual self-adjusting mechanical drum brakes on rear, hand lever parking brake, regenerative braking	✓	✓
WHEELS	4,8x8 LRC pneumatic tires	✓	✓
TRANSMISSION	Direct drive	✓	✓
SUSPENSION	Dual coil springs & shock absorber on front & rear	✓	✓
CHASSIS			
BODY	All steel unibody construction	✓	✓
COLOR	Security orange or federal yellow (optional colors available)		
LIGHTS	LED headlight & tail/brake light	✓	✓
OPERATOR COMPARTMENT			
STEERING	Handlebar	✓	✓
SEATS	Bucket seat on slide adjusters	✓	✓
INDICATORS	Battery status indicator	✓	✓
SAFETY	Reverse alarm, Deadman foot switch, Horn	✓	✓
ACCESSORIES	12V Accessories (optional DC converter available)	✓	✓

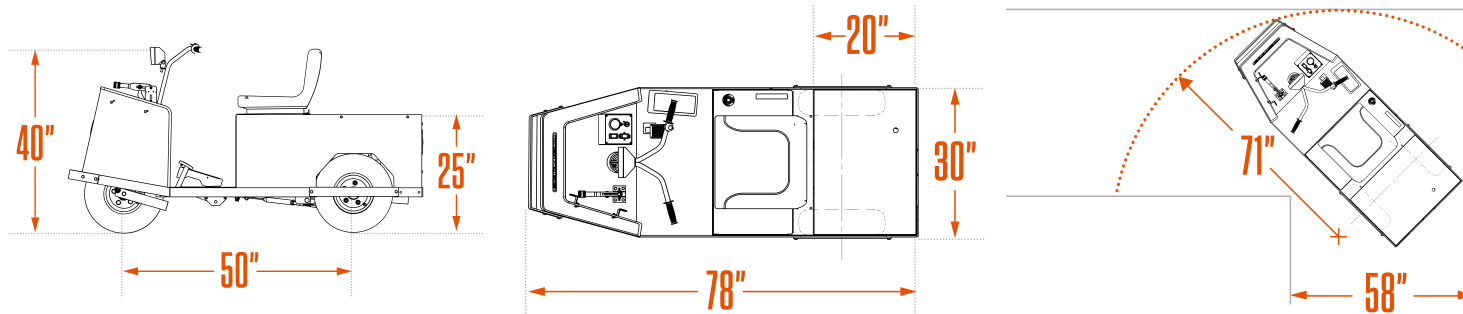

UNBEATABLE VEHICLES BACKED BY UNBEATABLE WARRANTIES

2-Year limited warranty on all Motrec vehicles with DC technology.



1 866 846-3558
MOTREC.COM

POPULAR OPTIONS

GET THE MOST FROM YOUR FLEET

MP 240

MODELS
24V | 36V

1 FOLDING SEAT AND REAR FOOTSTEP

Our folding seat gives you more versatility. You can quickly go from 1 to 2 passengers, or maximize your rear cargo space by folding the passenger seat.

2 LIGHTS

Maximize vehicle visibility & everyone's safety with a strobe light, blue safety light, tail and brake lights and more.

3 WHEELS AND SUSPENSION

Motrec offers a wide range of wheels to handle your specific use: non-marking solid tire wheel, rubber solid tire wheel, pneumatic on rim, traction tire, and more. The heavy duty suspension upgrades your loading capacity to 800 lbs.

4 HANDLE BAR OR STEERING WHEEL

Optional steering wheel option for optimal comfort and ergonomics.

5 BUMPER WITH HITCH PLATE

A must-have for attaching a trailer to boost cargo capacity. A wide range of hitches & hitch accessories to make attaching loads quick, easy & worry free.

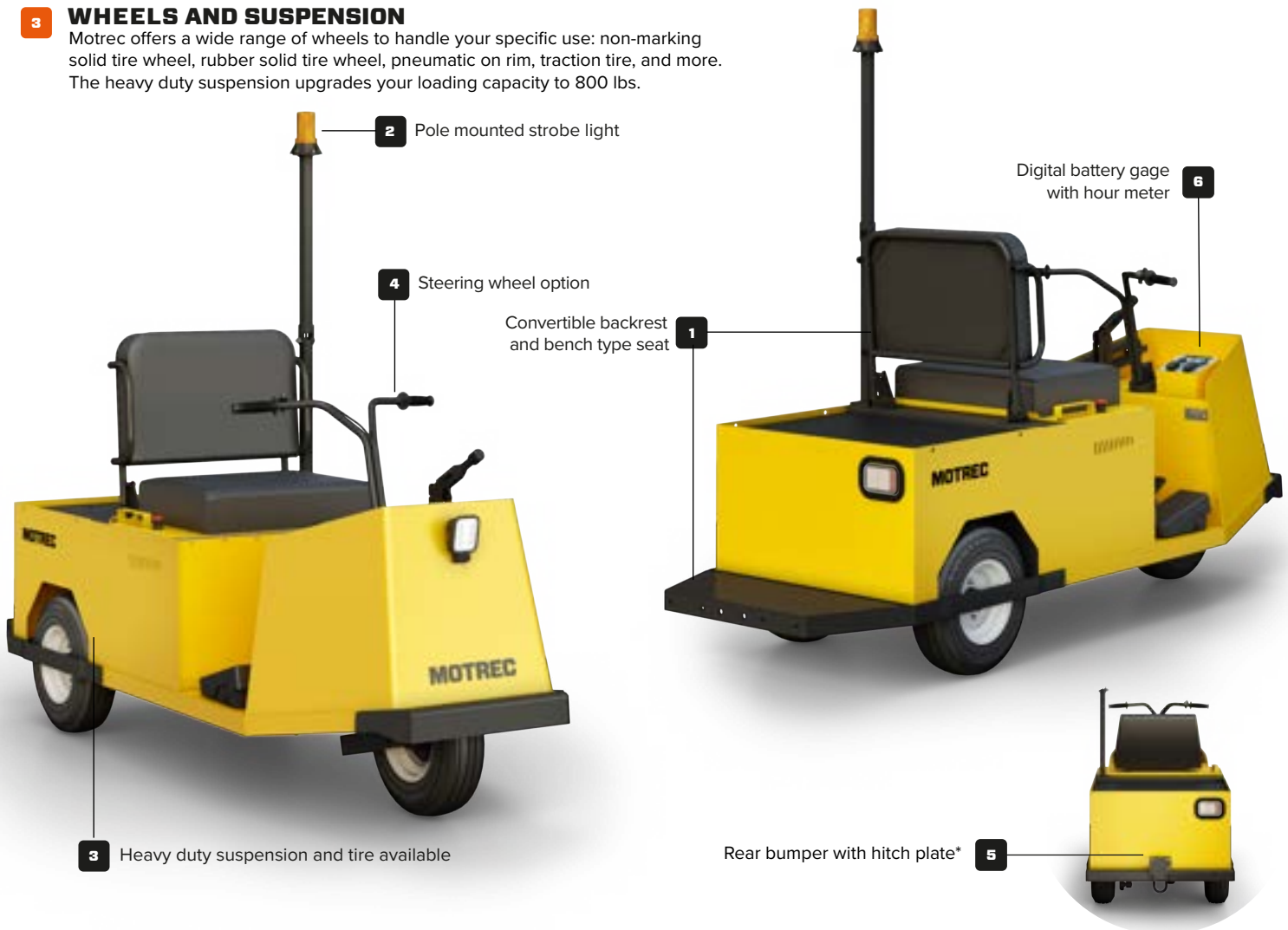

*Rear bumper with hitch plate isn't available with folding seat & rear footstep option. For compatibility, please contact your Motrec dealer. Options may vary from illustrations provided.

PERFORMANCE

- TOWING CAPACITY up to 6,000 lbs.
- WIDTH 30"
- SPEED up to 9 mph
- TURNING RADIUS 71"

UTILITY



BACKUP TUGGER
(UP TO 6000 LBS)



PEOPLE MOVER
(1 OR 2)



1 866 846-3558
MOTREC.COM