



JLG® ULTRA SERIES BOOM LIFTS



JLG® ULTRA BOOMS REACHING OUT

Steel mills and chemical plants, airports, convention centers, shipyards and heavy construction. The JLG® Ultra Series boom lifts are designed for rugged job sites that demand you work higher and reach farther. With five decades of experience, JLG knows the territory. You need the power, reliability and versatility to do the impossible every day. And come back and do it again tomorrow.

JLG Ultra Series boom lifts get you there. They're built from 100,000 psi steel—40% stronger than the competition, and they'll lift 1,000 pounds, making them the most powerful booms in the industry.

When you're working twelve stories high or more, you want a machine that gives you confidence to do your best work; that's built to perform and that's designed to meet any challenge—that's the JLG Ultra Series.

"No other machine allows us to reach as high or as far."





JLG ULTRA BOOM 1200SJP

1200SJP





MAXIMUM HEIGHT, REACH AND POWER

When your job demands both height and reach, enlist the Ultra Series Articulating models. The new 1500AJP provides 60 ft of up and over height and 75 ft of outreach while the 1250AJP has 63 ft of outreach, making these models ideal for applications that require high-reach versatility. The exclusive QuikStik® boom design provides faster cycle speeds from ground to full elevation—115 seconds for 1250AJP and 180 seconds for the 1500AJP. And the 1250AJP comes with the only oscillating axle in their boom class, giving you surprising mobility in an ultra-sized package.

“The larger platform gives us more room for tools and extra workers.”

FEATURES



Unmatched Range of Motion

A huge work envelope—up to 2.6 million cubic foot work envelope means you can access otherwise inaccessible areas.



Extendable Axles

Cylinder-deployed axles allow these boom lifts to grow from their transport width of 8' 2" to as wide as 16' 6" for unmatched rigidity and stability.



JibPLUS®

JibPLUS provides select Ultra Series models with up to 180 degrees of horizontal maneuverability for added versatility and improved productivity.



Four-Wheel Steering

All of our Ultra Series boom lifts offer 3 steering modes to meet the needs of diverse and ever-changing job sites.

Ultra Series
TELESCOPIC BOOM LIFTS

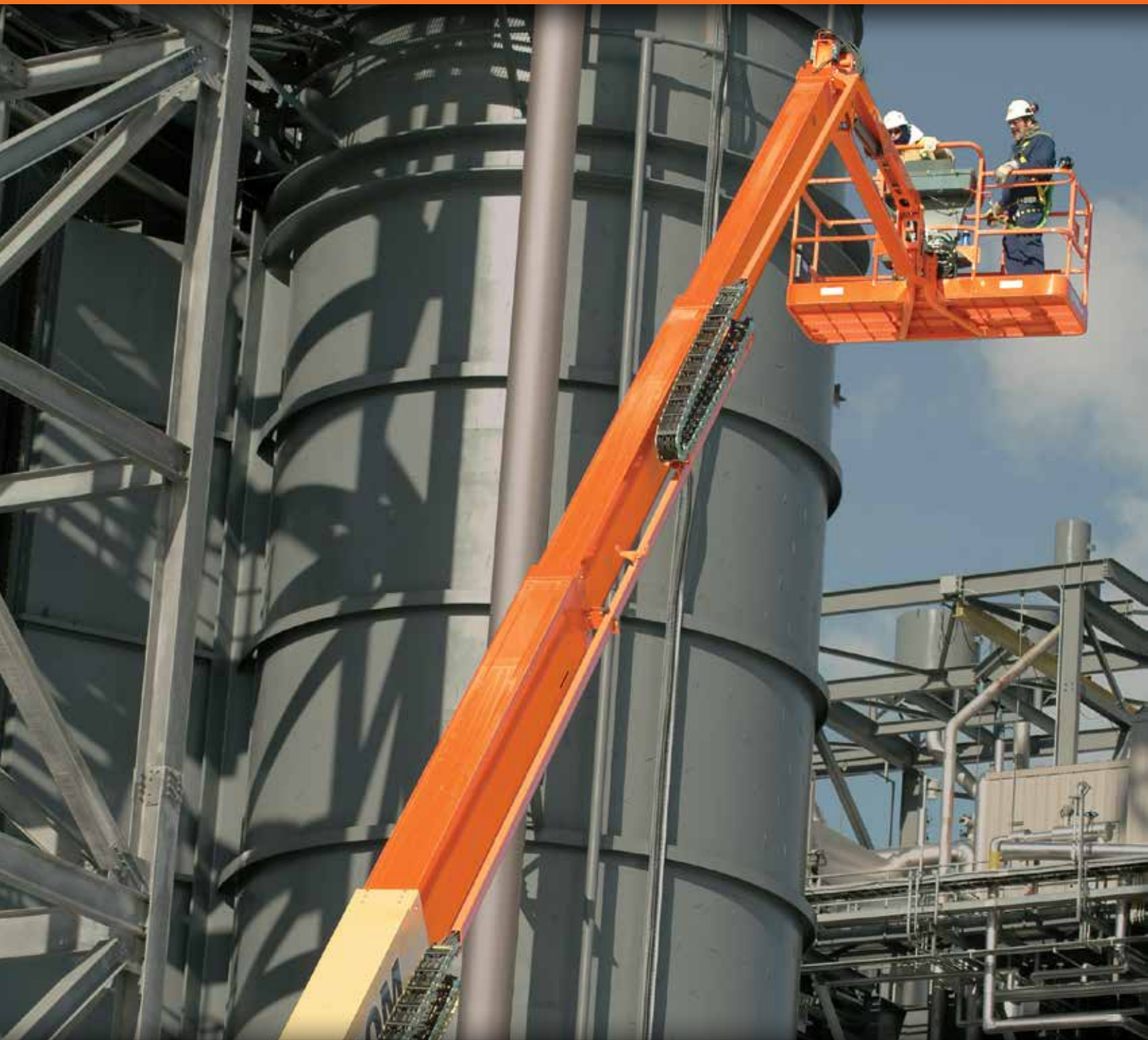

Strong 100,000 PSI Steel

The high-quality steel of the boom ensures greater durability and stability.



Larger Work Envelope

With more outreach above 50 ft, you have added access and flexibility.

TAKING PRODUCTIVITY TO GREATER HEIGHTS

Dominate the job site with the JLG® Ultra Series. When you're facing tall challenges, you want a solid machine that goes above and beyond the day's demands. The rugged boom gives you the confidence and support you need to handle 1,000 lb capacity. The exclusive controlled arc regulates speeds at the edges of the work envelope so that you feel the same velocity in all positions for enhanced comfort.

"The high capacity platforms raise our productivity, and level of work."



Oscillating Axle

Standard on all Telescopic Ultra Booms*, oscillating axle and full-time four-wheel drive provide superior traction.

**Except 1850SJ*



SkyPower®

A 7,500-watt on-board generator gives you the extra boost you need.

EXTEND YOUR REACH WITH THE 1500SJ

The Model 1500SJ is one of the largest self-propelled telescopic booms available from JLG—the first straight boom lift that takes you to 150 ft without an oversized load permit (over weight permit is required for highway transportation). The 1500SJ features a telescoping jib for greater work envelope flexibility and additional outreach at elevation.

“At 150 ft, I want to focus on my work with confidence. The Ultra Series lets me do just that.”



More Capacity

With a dual 1,000/500 lb capacity, the platform can handle more workers, tools or materials.



Greater Reach

The JibPLUS® boom adds an extra 30 ft of outreach.*

*Capacity restricted to 500 lb (227 kg) when the jib is in side-swing mode. JibPLUS for transport only for 1500SJ.



More Maneuverability

Full-time four-wheel drive gets you over rough terrain.



SkyGuard SkyLine™

Enhanced control panel protection comes standard with SkyGuard SkyLine™.

GO WHERE NO BOOM HAS GONE BEFORE WITH CONFIDENCE AT 185 FT

Introducing the highest reaching telescopic, self-propelled boom lift to ever hit the market. The 1850SJ features 19 stories of working height and a brand new chassis. The 1850SJ is much faster to full height, so operators can spend more time working and less time positioning the boom. The axles take approximately one minute to extend or retract. They're able to pivot in and out and do not telescope like extendable axles on other Ultra Series boom lifts.

Greater Work Envelope

Telescoping jib and five section boom provides 2.9 million cubic feet of work area and greater ability to reach up and over. Plus, the operator can move just the jib, rather than the whole machine, for greater maneuverability and more precise positioning.

*"I've never felt more confident
working from a machine of this caliber."*



New Chassis

Each axle is equipped with a linear sensor that works with the rotary sensor to keep steer wheels in the proper position.



Ease of Transport

No oversized load permit is needed (over weight permit is required for highway transportation).



LCD Screen

An LCD screen shows operators where they are in the work envelope along with other useful information.



Travel and Gradeability

Travel is permitted with platform at full elevation and features 40% gradeability in the stowed position.

WORKSTATION IN THE SKY® ACCESSORIES

Turn your engine powered aerial work platform into an integrated work tool with Workstation in the Sky® accessories. These packages are designed to increase your productivity, conserve platform space and improve working conditions.



SKYPOWER® PACKAGE

Machines with the SkyPower® system are equipped with a self-contained 7500W continuous output generator with a power cable, installed in the power track. In addition, it provides self-contained 110V-AC, 220V-AC and 3-phase power to run other accessories and hand tools.



SKYGLAZIER® PACKAGE

The first and only factory-approved glass and panel tray. Panels are protected from damage and productivity is improved while operator fatigue is reduced. And with JLG® 1,000 lb capacity, the basket can hold multiple workers and larger glass panels.



SKYCUTTER® PACKAGE

Eliminating the danger of tanks and draping hoses, SkyCutter® cuts faster and cleaner with an on-board Miller® Spectrum 375 Cutmate plasma cutter.



PIPE RACK ACCESSORY

Manufacturer-approved pipe racks provide positive retention of materials while storage outside the platform helps prevent rail damage and optimizes space.



SKYWELDER® PACKAGE

With a 280 amp Miller® CST 280 welder tucked into the SkyPower platform, space is conserved while providing stick and TIG capability. The SkyWelder® package eliminates potentially dangerous leads hanging over the rails and the unnecessary cost of a stand-alone welder and power supply.



BOLT-ON EXTERNAL FALL ARREST

Experience full 180 degree access around and 6' beyond the platform with the Bolt-On External Fall Arrest System. The slim design bolts on externally with ease and can be transferred to other JLG platforms in your fleet.



PUTTING YOUR WORK ABOVE EVERYTHING

When it comes to JLG® Support, it's all about you. Your productivity. Your profitability. Your uptime. From the purchase of your first piece of equipment straight through to the training, parts and maintenance that follows.



- **Customer Support Contact Center**
You can be assured we'll be giving an all-out effort to support you. Just think of us as your personal on-call, full-service support team. We make it happen. Period.
- **Financial Solutions**
Maximizing your profits. Preserving your cash flow. Let our financing specialists help choose the program designed specifically for your needs.
- **Aftermarket Parts**
Keep your equipment running at peak performance with genuine replacement parts, accessories, attachments, rebuilt and competitive parts all from one source — JLG.

- **Training**
Knowing your equipment inside and out results in higher productivity on the job. Our instructor-led courses give you the hands-on time you need to successfully operate equipment.
- **Service Centers**
Your needs. Your uptime. JLG is on the job to fulfill your every need, from repair, reconditioning, same-day parts and much more. We're here to support you.
- **Pre-Owned Equipment**
As a high-value alternative to purchasing new equipment, you can search our used equipment inventory of pre-owned JLG and competitor products.

Ultra Series SPECIFICATIONS

1250AJP

Ultra Series Articulating Boom Lifts Reach Specifications

Platform Height	125 ft (38.1 m)
Horizontal Reach	63 ft 2 in. (19.25 m)
Up and Over Height	60 ft 6 in. (18.44 m)
Swing	360° Continuous
Platform Capacity — Restricted	1,000 lb (454 kg)
Platform Capacity — Unrestricted	500 lb (227 kg)
Platform Rotator	180°
JibPLUS®	
Length	8 ft (2.44 m)
Horizontal Motion ¹	125°
Vertical Motion	130° (+75/-55)

Dimensional Data

A. Platform Size	36 x 96 in. (0.91 x 2.44 m)	
B. Overall Width	Axles Retracted	8 ft 2 in. (2.49 m)
	Axles Extended	12 ft 6 in. (3.81 m)
C. Tailswing	3 ft (91 cm)	
D. Stowed Height	10 ft (3.05 m)	
E. Overall Length	Jib Stowed	37 ft 7 in. (11.45 m)
	Jib Deployed	47 ft 6 in. (14.48 m)
F. Wheel Base	12 ft 6 in. (3.81 m)	
G. Ground Clearance	Axle	12 in. (30 cm)
	Chassis	25.5 in. (65 cm)
Weight ²	44,000 lb (19,958 kg)	

Chassis

Max Ground Bearing Pressure*	100 psi (7.03 kg/cm ²)	
Drive Speed	3.25 mph (5.2 km/h)	
Gradeability	45%	
Turning Radius (Inside)	Axles Retracted	14 ft 5 in. (4.39 m)
	Axles Extended	8 ft (2.44 m)
Turning Radius (Outside)	Axles Retracted	22 ft 6 in. (6.86 m)
	Axles Extended	19 ft 4 in. (5.89 m)
Crab Steer Ratio ³	1:1	
Axle Oscillation	8 in. (20 cm)	
Tires/Type	445/50D710 Foam Filled	

Power Source

Diesel Engine	Deutz TCD2.9L4 Tier 4 Final	74.2 hp (55.4 kW)
Fuel Tank Capacity		31 gal (117 L)
Hydraulic Reservoir		53 gal (200 L)
Auxiliary Power		12V DC
Generator Nominal/Continuous		7,500 Watt

*Ground bearing pressure applies to standard tires.

- Capacity is limited to 500 lb (227 kg) when JibPLUS is extended horizontally.
- Certain options or country standards increase weight.
- Ratio of forward travel to lateral travel.

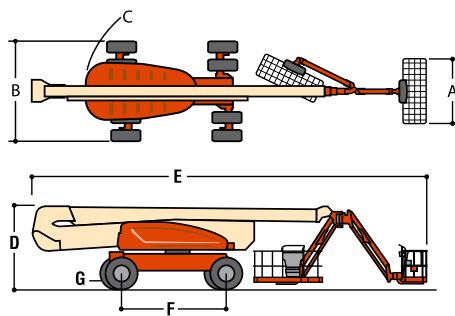

Standard Features

Platform: 36 x 96 in. (0.91 x 2.44 m) Side Entry
8 ft (2.44 m) JibPLUS® Boom
Selectable Capacity Envelope
180° Hydraulic Platform Rotator
AC Receptacle in the Platform
5 Degree Tilt Alarm/Indicator Light
All Motion Alarm
Swing-Out Engine Tray
12V DC Auxiliary Power
Hourmeter
Control ADE® System
Full-time 4WD
3 Selectable Steering Modes
Drive-out Extendible Axles
Oscillating Axle
Proportional Controls
Gull-Wing Hoods
445/50D710 Foam Filled Rim Protector Lug Tread Tires
Platform Console Machine Status Light Panel*
Lifting/Tie Down Lugs
Engine Distress Warning/Shutdown—Selectable via JLG Analyzer
SkyGuard SkyLine™

Available Options

Platform: 36 x 72 in. (0.91 x 1.83 m) Side Entry

Fall-Arrest Platform: 36 x 96 in. (0.91 x 2.44 m) Side Entry

Self-Closing Gate
Light Package¹
Flashing Beacon
Soft-Touch System Platform
6 ft/8 ft (1.83 m/2.44 m)
ClearSky (US and Canada only)
Cold Weather Start²
Hostile Environment Kit³
Mesh to Top Rail
Operator Tool Tray

- Includes platform mounted work lights and drive/backup lights.
- Includes glow plugs, battery heater and oil tank heater.
- Includes console cover, boom wipers and cylinder bellows.

Accessory Packages

SkyPower® Package
7500 Watt Generator
· 240/120V Single Phase
· 240V 3 Phase
1/2 in. Air Line to Platform

SkyWelder®
SkyCutter®
SkyGlazier®
Pipe Racks

* Provides indicator lights at platform control console for system distress, fuel level, low fuel, 5 degree tilt light and foot switch status.

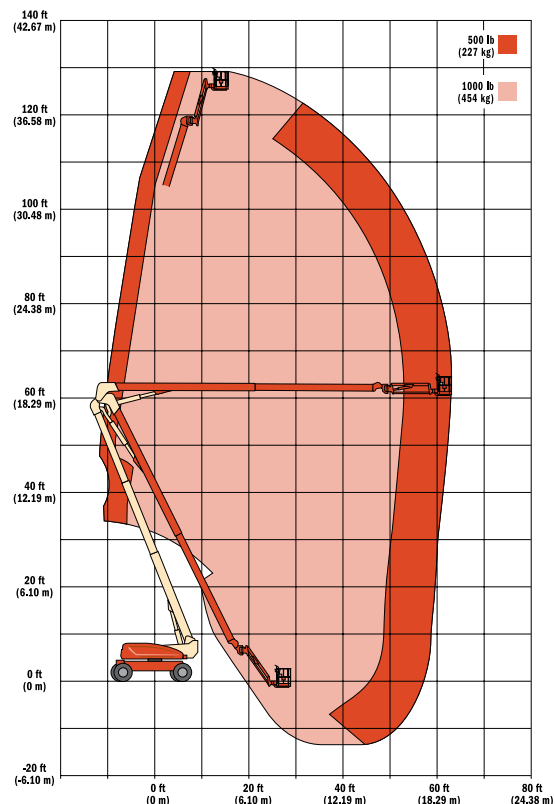

1500AJP

Ultra Series Articulating Boom Lifts
Reach Specifications

Platform Height	150 ft (45.72 m)
Horizontal Reach	75 ft (22.86 m)
Up and Over Height	60 ft (18.29 m)
Swing	360° Continuous
Platform Capacity — Restricted	1,000 lb (454 kg)
Platform Capacity — Unrestricted	600 lb 272 kg)
Platform Rotator	180°
JibPLUS [®]	
Length	8 ft (2.44 m)
Horizontal Motion ¹	125°
Vertical Motion	130° (+75/-55)

Dimensional Data

A. Platform Size	36 x 96 in. (0.91 x 2.44 m)
B. Overall Width	Axles Retracted 8 ft 1.5 in. (2.5 m)
Overall Width	Axles Extended 16 ft 6 in. (5 m)
C. Tailswing	0
D. Stowed Height	10 ft 2 in. (3.1 m)
E. Overall Length	Jib Stowed 39 ft 8 in. (12.09 m)
Overall Length	Jib Deployed 49 ft 8 in. (15.1 m)
F. Wheel Base	Extended 15 ft (4.6 m)
	Retracted 17 ft 1.5 in. (5.22 m)
G. Ground Clearance	Axle 9 in. (23 cm)
	Chassis 15.75 in. (40 cm)
Weight ²	57,400 lb (26,039 kg)

Chassis

Max Ground Bearing Pressure*	120 psi (83.7 kg/cm ²)
Drive Speed	2.8 mph (4.5 km/h)
Gradeability	40%
Turning Radius (Inside)	Axles Retracted 23 ft 4 in. (7.11 m)
	Axles Extended 7 ft 6 in. (2.28 m)
Turning Radius (Outside)	Axles Retracted 3 ft 3 in. (9.52 m)
	Axles Extended 21 ft 8 in. (6.6 m)
Crab Steer Ratio ³	1:1
Tires/Type	445/50D710 Foam Filled

Power Source

Diesel Engine	Deutz TCD 3.6L	99.8 hp (74.45 kW)
Fuel Tank Capacity		45 gal (170 L)
Hydraulic Reservoir		93 gal (352 L)
Auxiliary Power		12V DC
Generator Nominal/Continuous		7,500 Watt

*Ground bearing pressure applies to standard tires.

- Capacity is limited to 500 lb (227 kg) when JibPLUS is extended horizontally.
- Certain options or country standards increase weight.
- Ratio of forward travel to lateral travel.

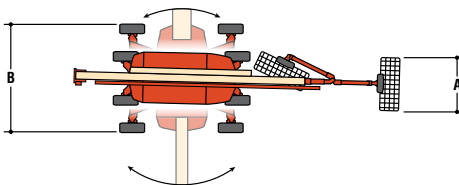
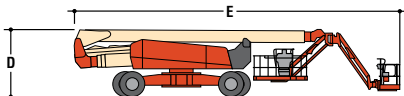

Standard Features

Platform: 36 x 96 in. (0.91 x 2.44 m) Side Entry
 8 ft (2.44 m) JibPLUS[®] Boom
 Selectable Capacity Envelope
 180° Hydraulic Platform Rotator
 AC Receptacle in the Platform
 5 Degree Tilt Alarm/Indicator Light
 All Motion Alarm
 Swing-Out Engine Tray
 12V DC Auxiliary Power
 Hourmeter
 Control ADE[®] System
 Full-time 4WD
 3 Selectable Steering Modes
 Drive-out Extendible Axles
 Proportional Controls
 Gull-Wing Hoods
 445/50D710 Foam Filled Rim Protector Lug Tread Tires
 Platform Console Machine Status Light Panel*
 Lifting/Tie Down Lugs
 Engine Distress Warning/Shutdown— Selectable via JLG Analyzer
 SkyGuard SkyLine™
 Control Console

Available Options

Platform: 36 x 72 in. (0.91 x 1.83 m) Side Entry
 Fall-Arrest Platform: 36 x 96 in. (0.91 x 2.44 m) Side Entry

Self-Closing Gate
 Light Package¹
 Flashing Beacon
 Soft-Touch System Platform
 6 ft/8 ft (1.83 m/2.44 m)
 ClearSky (US and Canada only)
 Cold Weather Start²
 Hostile Environment Kit³
 Mesh to Top Rail
 Operator Tool Tray

- Includes platform mounted work lights and drive/backup lights.
- Includes glow plugs, battery heater and oil tank heater.
- Includes console cover, boom wipers and cylinder bellows.

Accessory Packages

SkyPower[®] Package
 7500 Watt Generator
 · 240/120V Single Phase
 · 240V 3 Phase
 1/2 in. Air Line to Platform

SkyWelder[®]
 SkyCutter[®]
 SkyGlazier[®]
 Pipe Racks

* Provides indicator lights at platform control console for system distress, fuel level, low fuel, 5 degree tilt light and foot switch status.

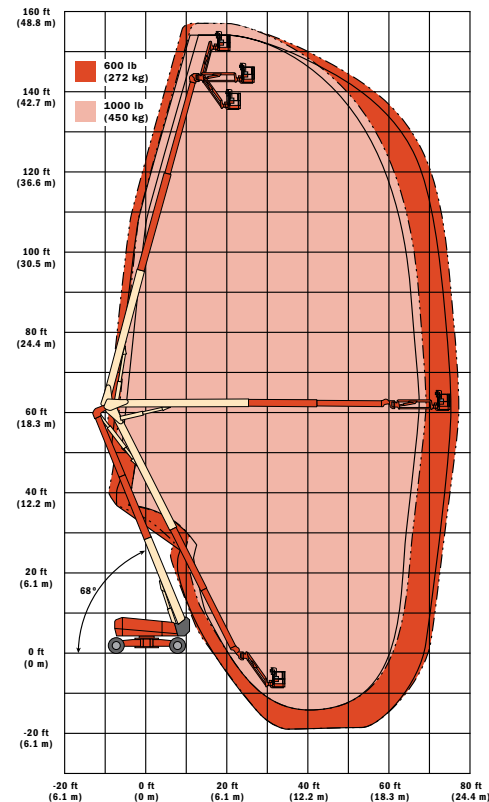

Ultra Series SPECIFICATIONS

1200SJ²

Ultra Series Telescopic Boom Lifts Reach Specifications

Platform Height	120 ft (36.58 m)
Horizontal Reach	75 ft (22.86 m)
Up and Over Height	—
Swing	360° Continuous
Platform Capacity — Restricted	1,000 lb (454 kg)
Platform Capacity — Unrestricted	500 lb (227 kg)
Platform Rotator	180°
JibPLUS [®]	
Length	8 ft (2.44 m)
Horizontal Motion ¹	180°
Vertical Motion	130° (+75/-55)

Dimensional Data

A. Platform Size		36 x 96 in. (0.91 x 2.44 m)
B. Overall Width	Axles Retracted	8 ft 2 in. (2.49 m)
Overall Width	Axles Extended	12 ft 6 in. (3.81 m)
C. Tailswing		5 ft 6 in. (1.67 m)
D. Stowed Height		10 ft (3.05 m)
E. Overall Length	Jib Stowed	34 ft 11 in. (10.64 m)
Overall Length	Jib Deployed	44 ft 10.25 in. (13.67 m)
F. Wheel Base		12 ft 6 in. (3.81 m)
G. Ground Clearance	Axle	12 in. (30 cm)
Chassis		25.5 in. (65 cm)
Weight ²		40,900 lb (18,552 kg)

Chassis

Max Ground Bearing Pressure*		99 psi (7.0 kg/cm ²)
Drive Speed		3.25 mph (5.2 km/h)
Gradeability		45%
Turning Radius (Inside)	Axles Retracted	14 ft 5 in. (4.39 m)
	Axles Extended	8 ft (2.44 m)
Turning Radius (Outside)	Axles Retracted	22 ft 6 in. (6.86 m)
	Axles Extended	19 ft 4 in. (5.89 m)
Crab Steer Ratio ³		1:1
Axle Oscillation		12 in. (30 cm)
Tires/Type		445/50D710 Foam Filled

Power Source

Diesel Engine	Deutz TCD2.9L4 Tier 4 Final	74.2 hp (55.4 kW)
Fuel Tank Capacity		31 gal (117 L)
Hydraulic Reservoir		55 gal (208 L)
Auxiliary Power		12V DC
Generator		7500 Watt

*Ground bearing pressure applies to standard tires.

- Capacity is limited to 500 lb (227 kg) when JibPLUS is extended horizontally.
- Certain options or country standards increase weight.
- Ratio of forward travel to lateral travel.

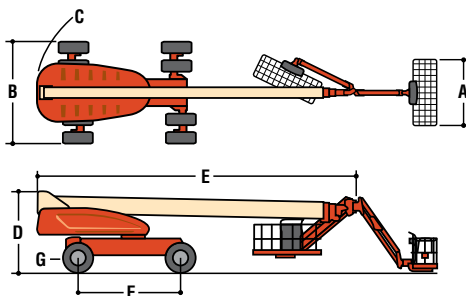

Standard Features

Platform: 36 x 96 in. (0.91 x 2.44 m) Side Entry
8 ft (2.44 m) JibPLUS[®] Boom
Selectable Capacity Envelope
180° Hydraulic Platform Rotator
AC Receptacle in the Platform
5 Degree Tilt Alarm/Indicator Light
All Motion Alarm
Swing-Out Engine Tray
12V DC Auxiliary Power
Hourmeter
Control ADE[®] System
Full-time 4WD
3 Selectable Steering Modes
Drive-out Extendible Axles
Oscillating Axle
Proportional Controls
Gull-Wing Hoods
445/50D710 Foam Filled Rim Protector Lug Tread Tires
Platform Console Machine Status Light Panel*
Lifting/Tie Down Lugs
Engine Distress Warning/Shutdown—Selectable via JLG Analyzer
SkyGuard SkyLine™

Available Options

Platform: 36 x 72 in. (0.91 x 1.83 m) Side Entry

Fall-Arrest Platform: 36 x 96 in.

(0.91 x 2.44 m) Side Entry

Self-Closing Gate

Light Package¹

Flashing Beacon

Soft-Touch System Platform

6 ft/8 ft (1.83 m/2.44 m)

ClearSky (US and Canada only)

Cold Weather Start²

Hostile Environment Kit³

Mesh to Top Rail

Operator Tool Tray

1. Includes platform mounted work lights and drive/backup lights.

2. Includes glow plugs, battery heater and oil tank heater.

3. Includes console cover, boom wipers and cylinder bellows.

Accessory Packages

SkyPower[®] Package

7500 Watt Generator

• 240/120V Single Phase

• 240V 3 Phase

1/2 in. Air Line to Platform

SkyWelder[®]

SkyCutter[®]

SkyGlazier[®]

Pipe Racks

* Provides indicator lights at platform control console for system distress, fuel level, low fuel, 5 degree tilt light and foot switch status.

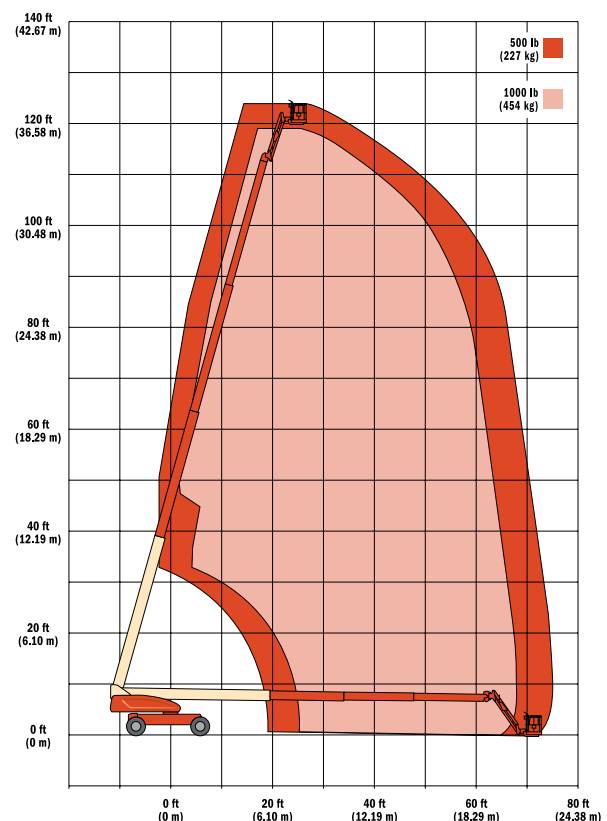

1350SJP

Ultra Series Telescopic Boom Lifts
Reach Specifications

Platform Height	135 ft (41.15 m)
Horizontal Reach	80 ft (24.38 m)
Up and Over Height	—
Swing	360° Continuous
Platform Capacity — Restricted	1,000 lb (454 kg)
Platform Capacity — Unrestricted	500 lb (227 kg)
Platform Rotator	180°
JibPLUS [®]	
Length	8 ft (2.44 m)
Horizontal Motion ¹	180°
Vertical Motion	130° (+75/-55)

Dimensional Data

A. Platform Size	36 x 96 in. (0.91 x 2.44 m)
B. Overall Width	Axles Retracted 8 ft 2 in. (2.49 m)
Overall Width	Axles Extended 12 ft 6 in. (3.81 m)
C. Tailswing	5 ft 6 in. (1.67 m)
D. Stowed Height	10 ft (3.05 m)
E. Overall Length	Jib Stowed 38 ft 11 in. (11.86 m)
Overall Length	Jib Deployed 48 ft 10.25 in. (14.89 m)
F. Wheel Base	12 ft 6 in. (3.81 m)
G. Ground Clearance	Axle 12 in. (30 cm)
	Chassis 25.5 in. (65 cm)
Weight ²	45,000 lb (20,411 kg)

Chassis

Max Ground Bearing Pressure*	107 psi (7.52 kg/cm ²)
Drive Speed	3.25 mph (5.2 km/h)
Gradeability	45%
Turning Radius (Inside)	Axles Retracted 14 ft 5 in. (4.39 m)
	Axles Extended 8 ft (2.44 m)
Turning Radius (Outside)	Axles Retracted 22 ft 6 in. (6.86 m)
	Axles Extended 19 ft 4 in. (5.89 m)
Crab Steer Ratio ³	1:1
Axle Oscillation	12 in. (30 cm)
Tires/Type	445/50D710 Foam Filled

Power Source

Diesel Engine	Deutz TD3.6L Tier IV Final	74.2 hp (55.4 kW)
Fuel Tank Capacity		31 gal (117 L)
Hydraulic Reservoir		55 gal (208 L)
Auxiliary Power		12V DC
Generator Nominal/Continuous		7,500 Watt

*Ground bearing pressure applies to standard tires.

- Capacity is limited to 500 lb (227 kg) when JibPLUS is extended horizontally.
- Certain options or country standards increase weight.
- Ratio of forward travel to lateral travel.

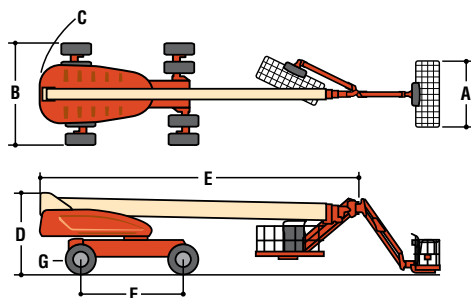

Standard Features

- Platform: 36 x 96 in. (0.91 x 2.44 m) Side Entry
- 8 ft (2.44 m) JibPLUS[®] Boom
- Selectable Capacity Envelope
- Inward Swinging Gate
- 180° Hydraulic Platform Rotator
- AC Receptacle in the Platform
- 5 Degree Tilt Alarm/Indicator Light
- All Motion Alarm
- Swing-Out Engine Tray
- 12V DC Auxiliary Power
- Hourmeter
- Control ADE[®] System
- Full-time 4WD
- 3 Selectable Steering Modes
- Drive-out Extendible Axles
- Oscillating Axle
- Proportional Controls
- Gull-Wing Hoods
- 445/50D710 Foam Filled Rim Protector Lug Tread Tires
- Platform Console Machine Status Light Panel*
- Lifting/Tie Down Lugs
- Engine Distress Warning/Shutdown—Selectable via JLG Analyzer
- SkyGuard SkyLine™

Available Options

- Platform: 36 x 72 in. (0.91 x 1.83 m) Side Entry

- Fall-Arrest Platform: 36 x 96 in. (0.91 x 2.44 m) Side Entry
 - Self-Closing Gate
 - Light Package¹
 - Flashing Beacon
 - Soft-Touch System Platform 6 ft/8 ft (1.83 m/2.44 m)
 - ClearSky (US and Canada only)
 - Cold Weather Start²
 - Hostile Environment Kit³
 - Mesh to Top Rail
 - Operator Tool Tray
- Includes platform mounted work lights and drive/backup lights.
 - Includes glow plugs, battery heater and oil tank heater.
 - Includes console cover, boom wipers and cylinder bellows.

Accessory Packages

- SkyPower[®] Package
 - 7500 Watt Generator
 - 240/120V Single Phase
 - 240V 3 Phase
 - 1/2 in. Air Line to Platform

- SkyWelder[®]
- SkyCutter[®]
- SkyGlazier[®]
- Pipe Racks

* Provides indicator lights at platform control console for system distress, fuel level, low fuel, 5 degree tilt light and foot switch status.

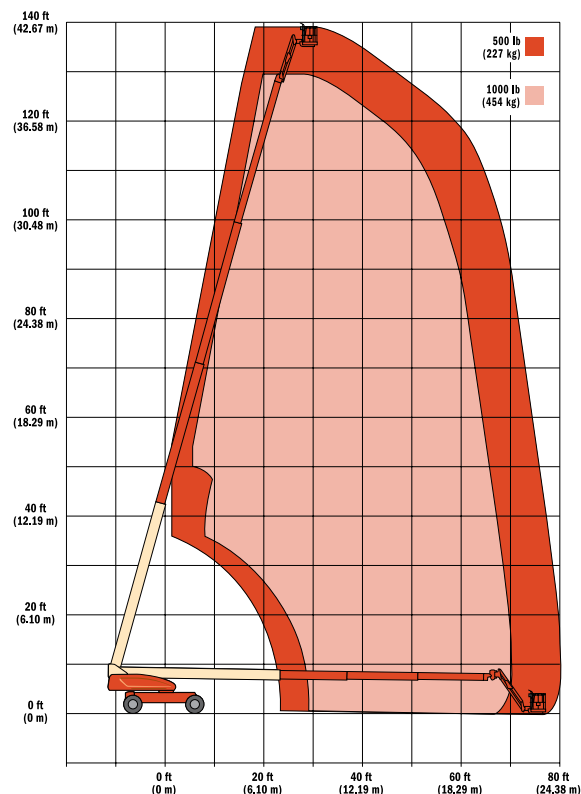

Ultra Series SPECIFICATIONS

1500SJ

Ultra Series Telescopic Boom Lifts Reach Specifications

Platform Height	150 ft (45.7 m)	
Horizontal Reach	80 ft (24.38 m)	
Up and Over Height	—	
Swing	360° Continuous	
Platform Capacity — Restricted	1,000 lb (454 kg)	
Platform Capacity — Unrestricted	500 lb (227 kg)	
Platform Rotator	180°	
Jib	Length	15 ft 2 in. - 25 ft (4.62 m - 7.62 m)
	Horizontal Motion ¹	For Transport Only
	Vertical Motion	120° (+75/-45)

Dimensional Data

A. Platform Size	36 x 96 in. (0.91 x 2.44 m)		
B. Overall Width	Axles Retracted	8 ft 2 in. (2.49 m)	
	Overall Width	Axles Extended	12 ft 6 in. (3.81 m)
C. Tailswing	5 ft 6 in. (1.67 m)		
D. Stowed Height	10 ft (3.05 m)		
E. Overall Length	Jib Stowed	43 ft (11.45 m)	
	Overall Length	Jib Deployed	61 ft 9 in. (18.82 m)
F. Wheel Base	12 ft 6 in. (3.81 m)		
G. Ground Clearance	Axle	12 in. (30 cm)	
	Chassis	25.5 in. (65 cm)	
Weight ²	48,000 lb (21,773 kg)		

Chassis

Max Ground Bearing Pressure*	113 psi (7.94 kg/cm ²)	
Drive Speed	3.0 mph (4.8 km/h)	
Gradeability	40%	
Turning Radius (Inside)	Axles Retracted	14 ft 5 in. (4.39 m)
	Axles Extended	8 ft (2.44 m)
Turning Radius (Outside)	Axles Retracted	22 ft 6 in. (6.86 m)
	Axles Extended	19 ft 4 in. (5.89 m)
Crab Steer Ratio ³	1:1	
Axle Oscillation	12 in. (30 cm)	
Tires/Type	445/50D710 Foam Filled	

Power Source

Diesel Engine	Deutz TCD2.9L4 Tier 4 Final	74.2 hp (55.4 kW)
Fuel Tank Capacity	31 gal (117 L)	
Hydraulic Reservoir	55 gal (208 L)	
Auxiliary Power	12V DC	
Generator	7,500 Watt	

*Ground bearing pressure applies to standard tires.

- Capacity is limited to 500 lb (227 kg) when Jib is extended.
- Certain options or country standards increase weight.
- Ratio of forward travel to lateral travel.

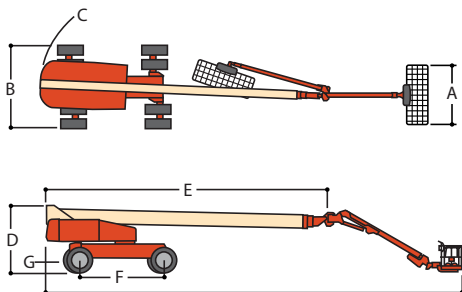

Standard Features

Platform: 36 x 96 in. (0.91 x 2.44 m) Side Entry
8 ft (2.44 m) JibPLUS[®] Boom
Selectable Capacity Envelope
180° Hydraulic Platform Rotator
AC Receptacle in the Platform
5 Degree Tilt Alarm/Indicator Light
All Motion Alarm
Swing-Out Engine Tray
12V DC Auxiliary Power
Hourmeter
Control ADE[®] System
Full-time 4WD
3 Selectable Steering Modes
Drive-out Extendible Axles
Oscillating Axle
Proportional Controls
Gull-Wing Hoods
445/50D710 Foam Filled Rim Protector Lug Tread Tires
Platform Console Machine Status Light Panel*
Lifting/Tie Down Lugs
Engine Distress Warning/Shutdown—Selectable via JLG Analyzer
SkyGuard SkyLine™

Fall-Arrest Platform: 36 x 96 in. (0.91 x 2.44 m) Side Entry

Self-Closing Gate

Light Package¹

Flashing Beacon

Soft-Touch System Platform
6 ft/8 ft (1.83 m/2.44 m)

ClearSky (US and Canada only)

Cold Weather Start²

Hostile Environment Kit³

Mesh to Top Rail

Operator Tool Tray

1. Includes platform mounted work lights and drive/back-up lights.

2. Includes glow plugs, battery heater and oil tank heater.

3. Includes console cover, boom wipers and cylinder bellows.

Accessory Packages

SkyPower[®] Package

7500 Watt Generator
- 240/120V Single Phase
- 240V 3 Phase
1/2 in. Air Line to Platform

SkyWelder[®]

SkyCutter[®]

SkyGlazier[®]

Pipe Racks

Available Options

Platform: 36 x 72 in. (0.91 x 1.83 m) Side Entry

* Provides indicator lights at platform control console for system distress, fuel level, low fuel, 5 degree tilt light and foot switch status.

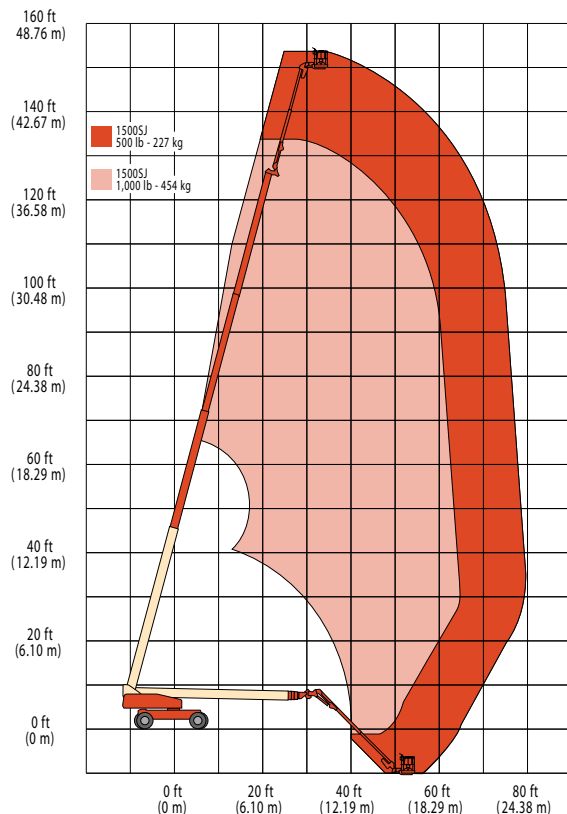

1850SJ

Ultra Series Telescopic Boom Lifts
Reach Specifications

Platform Height	185 ft 7 in. (56.56 m)	
Horizontal Reach	80 ft (24.38 m)	
Swing	360° Continuous	
Platform Capacity — Restricted	1,000 lb (454 kg)	
Platform Capacity — Unrestricted	500 lb (227 kg)	
Platform Rotator	173° Hydraulic	
Jib	Length	13 ft (3.96 m)
	Horizontal Motion ¹	For Transport Only
	Vertical Motion	120° (+75/-45)

Dimensional Data

A. Platform Size	36 x 96 in. (.91 x 2.44 m)	
B. Overall Width	Axles Retracted	8 ft 2 in. (2.49 m)
	Axles Extended	16 ft 6 in. (5.03 m)
C. Tailswing	7 ft 7 in. (2.32 m)	
D. Stowed Height	10 ft (3.05 m)	
E. Overall Length	Jib Stowed	47 ft 9.5 in. (14.57 m)
	Jib Deployed	63 ft 10 in. (19.45 m)
F. Wheel Base	17 ft 7 in. (5.36 m)	
G. Ground Clearance	Axle	13.5 in. (34 cm)
	Chassis	16.25 in. (41 cm)
Weight ¹	59,930 lb (27,184 kg)	

Chassis

Max Ground Bearing Pressure*	119.6 psi (8.41 kg/cm ²)	
Drive Speed	2.8 mph (4.5 km/h)	
Gradeability	40%	
Turning Radius (Inside)	Axles Retracted	23 ft 4 in. (7.12 m)
	Axles Extended	7 ft 7 in. (2.3 m)
Turning Radius (Outside)	Axles Retracted	31 ft 3 in. (9.52 m)
	Axles Extended	21 ft 8 in. (6.6 m)
Crab Steer Ratio ²	1:1	
Tires/Type	445/50D710 Foam Filled	

Power Source

Diesel Engine	Deutz TD3.6L Tier 4 Final	99.8 hp (74.4 kW)
Fuel Tank Capacity	52.8 gal (200 L)	
Hydraulic Reservoir	75.1 gal (284.2 L)	
Auxiliary Power	12V DC	
Generator	7,500 Watt	

*Ground bearing pressure applies to standard tires.

- Capacity is limited to 500 lb (227 kg) when Jib is extended.
- Certain options or country standards increase weight.
- Ratio of forward travel to lateral travel.

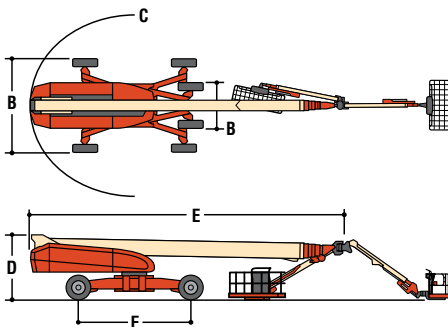

Standard Features

- Platform 36 x 96 in. (.91 x 2.44 m) Side Entry
- Selectable Capacity Envelope
- Drive-Out Extendable Axles
- 173° Hydraulic Platform Rotator
- AC Receptacle in Platform
- Tilt Light and Alarm
- Swing-Out Engine Tray
- 12V-DC Auxiliary Power
- Hourmeter
- Control ADE® System
- Full-Time 4WD
- 3 Selectable Steering Modes
- Proportional Controls
- Gull-Wing Steel Hoods
- 445/50D710 Foam-Filled Rim Protector
- Lug Tread Tires
- Platform Console Machine Status Light Panel*
- Lifting/Tie Down Lugs
- Engine Distress Warning/Shutdown—Selectable via JLG Analyzer
- All Motion Alarm
- Glow Plugs
- LCD Panel at Operator's Platform
- Control Console
- SkyGuard SkyLine™
- 36 x 72 in. (.91 x 1.83 m) Platform
- Inward Self-Closing Swing Gate

- Fall Arrest Platform 36 x 96 in. (.91 x 2.44 m) Rear Entry⁵
- Mesh to Top Rail-Bolt-on Aluminum 6 ft³
- Mesh to Top Rail-Bolt-on Aluminum 8 ft³ Light Package¹
- Soft Touch System
- Cold Weather Start Kit²
- Hostile Environment Kit³
- Flashing Amber Beacon
- Cold Package Plus⁴
- Tool Tray
- Special Hydraulic Oils

 - Includes platform mounted worklights and drive/backup lights.
 - Includes battery heater and oil tank heater.
 - Includes console cover, boom wipers and cylinder bellows.
 - Includes extreme cold engine oil, fuel conditioner, engine block heater, battery blanket, glow plugs, hydraulic tank heater, and oversized footswitch. Arctic hydraulic oil priced separately.
 - Not available in all markets.

Accessory Packages

- SkyPower® Package
 - 7500 Watt Generator
 - 240/120V Single Phase
 - 240V 3 Phase
 - 1/2 in. Air Line to Platform
- SkyWelder® Package
- SkyCutter®
- SkyGlazier®
- Pipe Rack

Available Options

- 36 x 72 in. (.91 x 1.83 m) Platform
- Inward Self-Closing Swing Gate

* Provides indicator lights at platform control console for system distress, fuel level, low fuel, 5 degree tilt light and foot switch status.

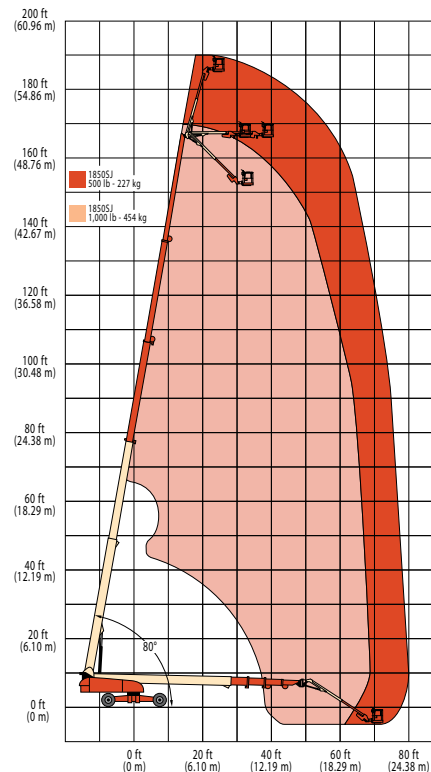



(844) 432-4724

fairchildequipment.com

JLG Industries, Inc.

1 JLG Drive
McConnellsburg, PA 17233-9533
Telephone 717-485-5161
Toll-free in US 877-JLG-LIFT
Fax 717-485-6417

www.jlg.com

An Oshkosh Corporation Company

Part No.: 3131561
R051922
Printed in USA

